

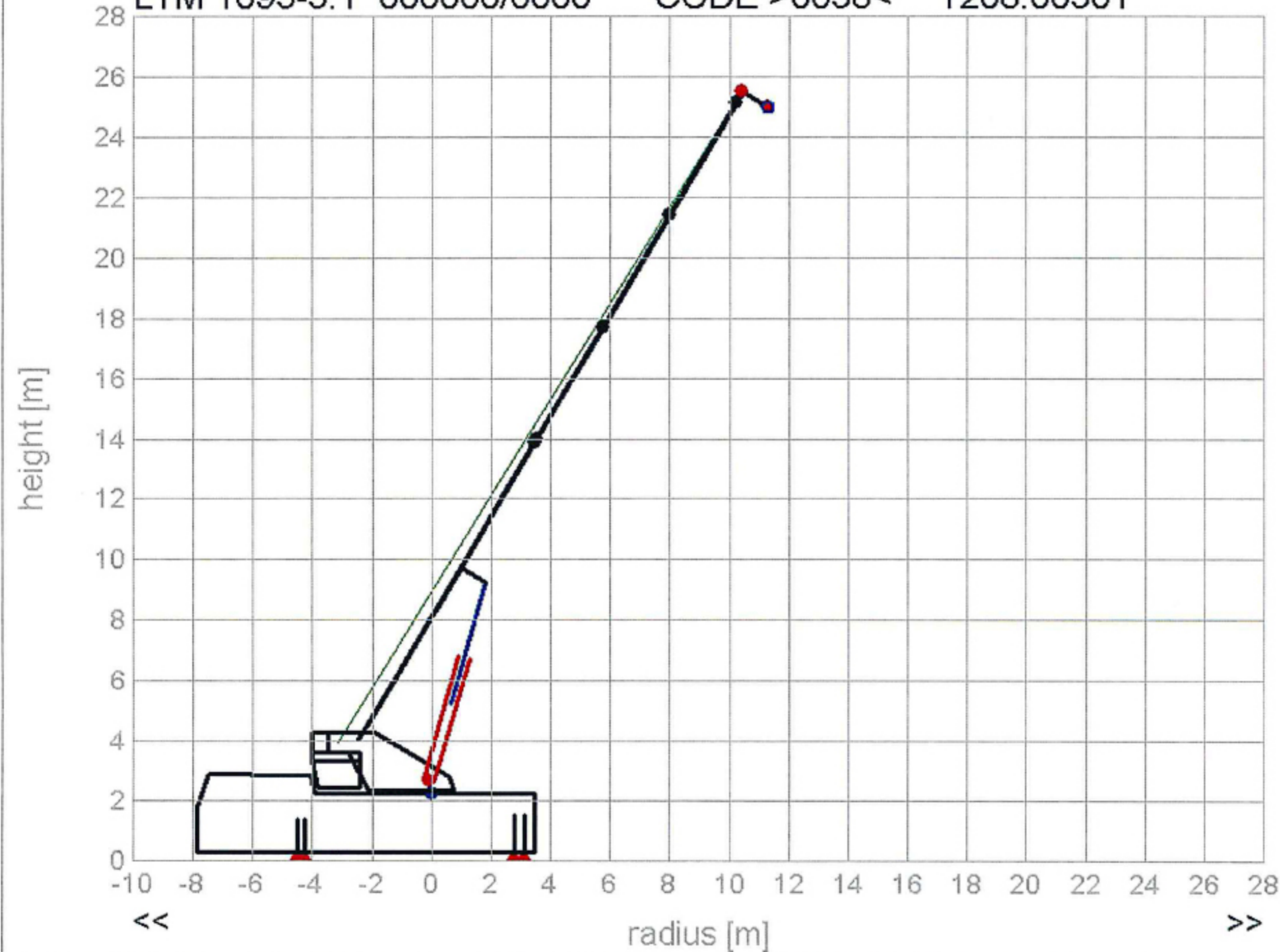





LTM 1095-5.1 000000/0000 CODE >0038< T208.00301







t
n=9
20⁰
23¹
(max)

m
11.3
59.0°

t
m
%
18⁸
25.0
0+ 46+ 46+ 46+ 0+

m
25.0

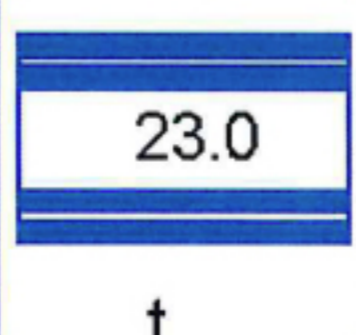
0.0°



T
--

7.34 x
23.0
7.00
m

360°